



CÔNG TY TNHH MIDRA VIỆT NAM  
MIDRA VIET NAM CO., LTD

# CATALOGUE

## ỐNG KHỚP NỐI GIÁ KỆ



***Siêu tiện lợi***  
[www.ongkhopnoi.com](http://www.ongkhopnoi.com)

# ABOUT MIDRA

## PRODUCTS CATALOGUE PIPE RACKING & SHELVING SYSTEM

CÔNG TY TNHH MIDRA VIỆT NAM



### Tự hào sứ mệnh

- Phát triển thành một trong những tập đoàn công nghiệp hàng đầu Việt Nam.
- Cung ứng những giải pháp & dịch vụ công nghiệp **hiện đại, hiệu quả, dựa trên tri thức.**
- Góp phần đưa Việt Nam cất cánh trở thành một quốc gia có nền công nghiệp phát triển hàng đầu thế giới vào năm 2045.



www.midra.vn

## ĐỊA CHỈ UY TÍN HÀNG ĐẦU CHO CÁC NHÀ MÁY FDI

Là Vendor- Nhà cung cấp trực tiếp vào các nhà máy:



Là đại lý chính thức tại Việt Nam của:



VPGD: SN21-TT21- Khu đô thị mới Văn Phú – Hà Đông – Hà Nội

VP HCM: No.38/8, đường số 8, Ph. Hiệp Bình Phước, quận Thủ Đức, Thành phố Hồ Chí Minh

Tel: 024 6682 5694 (Fax:0433119295) Hotline: 0982800084 / Midra@Midra.vn



## About Midra

Vietnam's economy is currently undergoing industrialization and modernization, with the construction of numerous new factories and the expansion of existing facilities. Consequently, the demand for supportive services in industrial production is increasingly high, requiring superior quality, timely delivery, and exceptional service.

Midra Vietnam Co., Ltd. was established with the aim of contributing to the society's development and the country's progress by providing top-notch, comprehensive industrial services and solutions. Our team comprises young, honest, and eager-to-learn professionals who undergo continuous training, striving to deliver reputable, professional, and innovative industrial products and services.

Our ultimate goal is to foster a sustainable and harmonious work environment and collaboration, where mutual support is readily available. Above all, we prioritize being "ALWAYS RELIABLE," aspiring to enhance Vietnam's reputation in the eyes of international partners and friends.

## PIPES

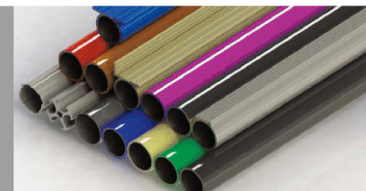

## Giới thiệu về Midra

Nền kinh tế Việt Nam đang trên con đường công nghiệp hóa, hiện đại hóa, với nhiều nhà máy được xây dựng mới và nhiều công trình hiện tại đã, đang tiếp tục mở rộng. Do đó nhu cầu về các dịch vụ phụ trợ trong sản xuất công nghiệp ngày càng yêu cầu cao hơn về chất lượng và tiến độ cũng như dịch vụ.

Công ty TNHH Midra Việt Nam ra đời với mục đích đóng góp cho sự phát triển của xã hội và sự đi lên của đất nước, thông qua việc cung ứng các dịch vụ và giải pháp công nghiệp tốt, toàn diện. Với đội ngũ nhân viên trẻ, trung thực, ham học hỏi và được đào tạo liên tục chúng tôi mong muốn mang đến các sản phẩm giải pháp và dịch vụ công nghiệp uy tín, chuyên nghiệp và không ngừng đổi mới nhằm tạo ra môi trường làm việc và hợp tác bền vững, hài hòa, sẵn sàng hỗ trợ lẫn nhau và đặc biệt "LUÔN LUÔN ĐÁNG TIN CẬY" để góp phần nâng tầm Việt Nam trong mắt đối tác và bạn bè quốc tế.

### CÔNG TY TNHH MIDRA VIỆT NAM

VPGD: SN21-TT21- Khu đô thị mới Văn Phú – Hà Đông – Hà Nội

VP HCM: No.38/8, đường số 8, Ph. Hiệp Bình Phước, quận Thủ Đức, Thành phố Hồ Chí Minh

Tel: 024 6682 5694 (Fax:0433119295) Hotline: 0982800084

Mail: Midra@Midra.vn

Website: www.midra.vn / onghopnoi.com

### ■ Pipe code system

CP	28	10	X
Pipe Type	Size	Steel-Thickness	ABS-Color
*CP - Coated Pipe	*Φ28mm	*T - 0.7	*IV - IVORY
*DCP - Double Coated Pipe	*Φ32mm	*T - 1.0	*BK - BLACK
*ST - Stainless steel Pipe		*T - 2.0	*BL - BLUE
*AL - Aluminium Pipe			*GE - GREEN
*SP - Slide Pipe		ST-Thickness	*SI - SILVER
*SG - Slide Guide Pipe		*T - 0.7	*RD - RED
*FP - Flat Pipe		*T - 0.9	*GR - GREY
*FL - Flange Pipe		*T - 1.2	*LB - LIGHT BROWN
*ESP - (LINE) ESD Pipe			*WH - WHITE
*EBP - (BLACK) ESD Pipe			*YE - YELLOW
*ECP - ESD Pipe			*PK - PINK
			*BR - BROWN
			*OR - ORANGE
			ST-Material
			*2 - 200 Series
			*4 - 400 Series



## Coated & Double Coated Pipe

### Coated Pipe

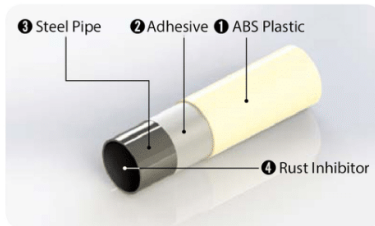

### Double Coated Pipe

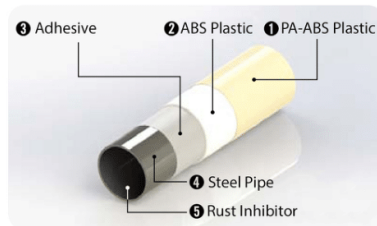

#### ※ Features

- Light and durable resin coated structural steel pipe.
- Clean surface with rust-proof spraying inside.
- Various color selections applied to the working environment and preference.
- More economic and lighter systems than generally used racking & shelving system.

#### Chemical Tests

No	Test Conditions	Test Method	Result		Remark
			Coated pipe	Double coated pipe	
1	UV	floodlight	X	O	
2	cutting oil	apply	X	O	
3	inhibited oil	apply	△	O	
4	methanol	deposition	X	X	
5	toluene	deposition	X	X	
6	machine oil	apply	X	O	
7	bleaching agents for industry	apply	O	O	
8	household bleach	apply	O	O	
9	methyl alcohol	deposition	X	X	
10	cooking oil	apply	△	O	
11	saline solution	apply	X	O	
12	hydrochloric acid	apply	X	X	
13	Carbonated Water	apply	O	O	

1. Test period: 30 days

2. Note: O - unchanged      △ - potential for change      X - change surface

## ESD Pipe

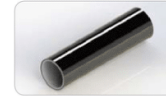

### ESD Black

- Coated with Carbon black to increase the surface resistance. ( $10^4 \sim 10^5$ )

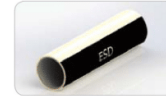

### ESD Stripe

- Coated with Carbon black on the ABS to increase the durability

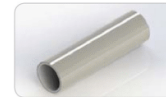

### ESD Grey

- Coated with the PE - ESD composition
- The surface resistance is higher than Carbon black's

## Variable Pipe

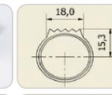

### Slide Pipe

- The thread shaped pipe for flow rack

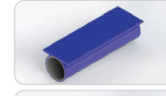

### Flat Pipe

- Flat shaped pipe for hanging tool box and rack shelf support etc.



### Slide Guide Pipe

- L - shaped pipe acts as a side guide

## Stainless Steel Pipe



### STS Pipe

- Features
- Recyclable environment friendly product.
- Light weight and high strength.
- No toxic smells during cutting.
- Minimal containment by oil and chemical spill.
- Conductive and antistatic property.
- Assembled in various types.
- Proper in clean room.

## Aluminium Pipe













### Standard Pipe

- Substitute for ABS Coated Pipe for rack structures



### Solid Pipe

- Light weight, high strength and suitable for an heavy rack structures.
- Available with Rubber Guide

Specification					
Type	Part No	Spec	Diameter(mm)	Thickness	Standard Length(mm)
Coated Pipe	MID-CP2807		Ø28	t0.7	4,000
	MID-CP2810		Ø28	t1.0	
	MID-CP2820		Ø28	t2.0	
Double Coated Pipe	MID-CP2807		Ø28	t0.7	
	MID-CP2810		Ø28	t1.0	
	MID-CP2820		Ø28	t2.0	
ESD Stripe Pipe	MID-ESP2807		Ø28	t0.7	
	MID-ESP2810		Ø28	t1.0	
ESD Black Pipe	MID-EBP2807		Ø28	t0.7	
	MID-EBP2810		Ø28	t1.0	
ESD Grey Pipe	MID-ECP2807		Ø28	t0.7	
	MID-ECP2810		Ø28	t1.0	
Slide Pipe	MID-SP2807		Ø28	t0.7	
	MID-SP2810		Ø28	t1.0	
Slide Guide Pipe	MID-SG2807		Ø28	t0.7	
	MID-SG2810		Ø28	t1.0	
Flat Pipe	MID-FL2807		Ø28	t0.7	
	MID-FL2810		Ø28	t1.0	
STS Pipe	MID-ST2807		Ø28	t0.7	
	MID-ST2809		Ø28	t0.9	
	MID-ST2812		Ø28	t1.2	
Aluminium Pipe	MID-AL2810		Ø28	t1.0	
	MID-AL2820		Ø28	t2.0	

Pipe Color						
Type	Color	Pipe Specification			Remark	
		Coated	Double Coated	ESD		
Single & Double Coated	Ivory	■	■	-		
	Light Blue	■	■	-		
	Dark Blue	■	■	-		
	Light Green	■	■	-		
	Green	■	■	-		
	Orange	■	■	-		
	Brown	■	■	-		
	Red	■	■	-		
	Yellow	■	■	-		
	Pink	■	■	-		
	Purple	■	■	-		
	White	■	■	-		
	Black	■	■	-		
	Light Grey	■	■	-		
	Dark Grey	■	■	-		
	ESD	Grey	-	-	■	
Black		-	-	■		
Ivory/Black		-	-	■		



## METAL JOINTS

### Part code system

MID-D	S1	X
Joint Type	Part No	Color
*D - Metal Joint(Single)	*S1	*Z - Zinc
*DJ - Metal Joint(sets)	*S2	*B - Black
	*S3	*N - Nickel
		*C - Chromium



## METAL JOINTS (Single)

• Usage :  $\Phi 28$   
• Unit : mm  
• Color : Zinc/Black/Nickel/Chromium

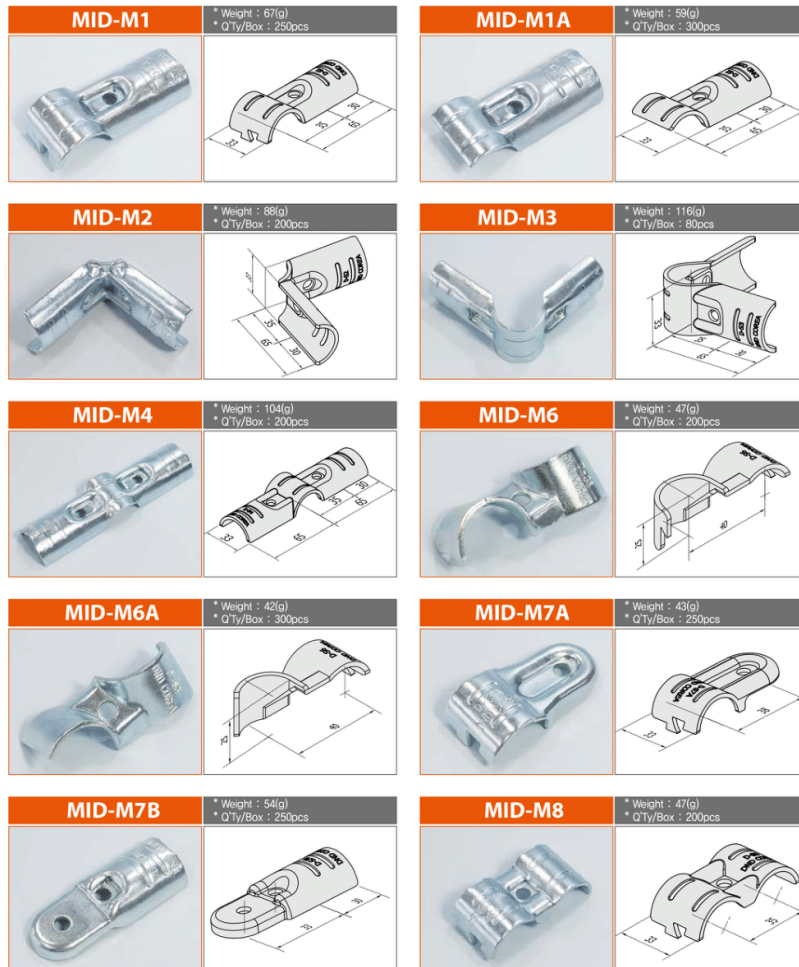

## METAL JOINTS (Single)

• Usage :  $\Phi 28$   
• Unit : mm  
• Color : Zinc/Black/Nickel/Chromium



## METAL JOINT SETS

• Usage :  $\Phi 28$   
• Unit : mm  
• Color : Zinc/Black/Nickel/Chromium



## METAL JOINT SETS

\*Usage :  $\Phi 28$   
\*Unit : mm  
\*Color : Zinc/Black/Nickel/Chromium

<b>MID-DJ-M8A</b>	* D-S8A:2pcs * Bolt,Nut:1set	<b>MID-DJ-M9</b>	* D-S9:2pcs / DJP-9C:1pcs * Bolt,Nut:1set
			
<b>MID-DJ-M10</b>	* D-S10A:1pcs / D-S10B:1pcs * Bolt,Nut:1set	<b>MID-DJ-M11</b>	* D-S11:2pcs / D-S7B:4pcs * Bolt,Nut:4sets
			
<b>MID-DJ-M12</b>	* D-S12:2pcs * Bolt,Nut:1set	<b>MID-DJ-M13A</b>	* D-S13A:1pcs/D-S13B:1pcs * Bolt:1pcs
			
<b>MID-DJ-M13B</b>	* D-S14:2pcs /DJP-9C:2pcs * Bolt:1pcs	<b>MID-DJ-M13C</b>	* D-S15:2pcs * Bolt:1pcs
			
<b>MID-DJ-M14</b>	* D-S14:2pcs /DJP-9C:2pcs * Bolt,Nut:1set	<b>MID-DJ-M15</b>	* D-S15:2pcs * Bolt,Nut:1set
			

## PLASTIC JOINTS



### Part code system

MID-DJP	107D	X
Joint Type	Part No	Color
*DJP - Plastic Joint	*107D	*IV - IVORY *BK - BLACK *BL - BLUE *NO - Normal



• Usage :  $\Phi 28$   
 • Unit : mm  
 • Color : Ivory/Black/Grey/White/Blue

## PLASTIC JOINTS

<b>MID-DJP-105</b>	Plastic Joint • Weight : 36(g) • Qty/Box : 150pcs	<b>MID-DJP-107D</b>	Plastic Joint • Weight : 31(g) • Qty/Box : 150pcs
<b>MID-DJP-104C</b>	Plastic Joint • Weight : 49(g) • Qty/Box : 100pcs	<b>MID-DJP-104D</b>	Plastic Joint • Weight : 47(g) • Qty/Box : 100pcs
<b>MID-DJP-159</b>	Plastic Joint • Weight : 18(g) • Qty/Box : 250pcs	<b>MID-DJP-117R/117L</b>	Self Cart Handles • Weight : 84(g)/2pcs • Qty/Box : 130pcs
<b>MID-DJP-201</b>	Plastic Divider • Weight : 16(g) • Qty/Box : 250/400pcs	<b>MID-DJP-123</b>	Slide Joint • Weight : 21(g) • Qty/Box : 250pcs
<b>MID-DJP-5</b>	Corner Base • Weight : 60(g) • Qty/Box : 60pcs	<b>MID-DJP-202</b>	Plate Holder • Weight : 12(g) • Qty/Box : 250/500pcs

<b>MID-DJP-38S</b>	Horizontal Support • Weight : 5(g) • Qty/Box : 400/1,200pcs	<b>MID-DJP-146</b>	Horizontal Support • Weight : 14(g) • Qty/Box : 400pcs
<b>MID-DJP-9C</b>	Sleeve for DJ-S9 • Weight : 7(g) • Qty/Box : 300pcs	<b>MID-DJP-49A</b>	Outer Cap • Weight : 6(g) • Qty/Box : 300pcs
<b>MID-DJP-49B</b>	Outer Cap • Weight : 8(g) • Qty/Box : 300pcs	<b>MID-DJP-110</b>	Inner Cap • Weight : 5(g) • Qty/Box : 300pcs
<b>MID-DJP-38A</b>	Horizontal Support • Weight : 4(g) • Qty/Box : 400pcs	<b>MID-DJP-38B</b>	Level Holder • Weight : 5(g) • Qty/Box : 400pcs
<b>MID-DJP-38C</b>	Edge Holder • Weight : 3(g) • Qty/Box : 400pcs	<b>MID-DJP-112</b>	Inner Cap • Weight : 4(g) • Qty/Box : 500pcs

APPLICATIONS | TECHNICAL SPECIFICATIONS | ACCESSORIES | SLIDE PIPE MOUNT BRACKETS | PVC MOUNT BRACKETS | PLASTIC WHEEL CONVEYORS | METAL JOINTS | PIPES

## PLASTIC JOINTS

\* Usage :  $\Phi 28$   
\* Unit : mm  
\* Color : Ivory/Black/Grey/White/Blue

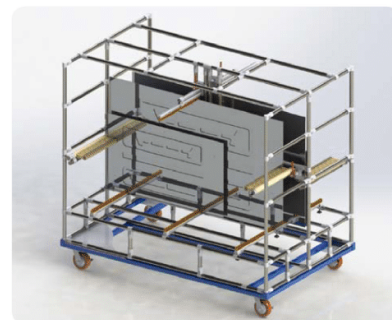
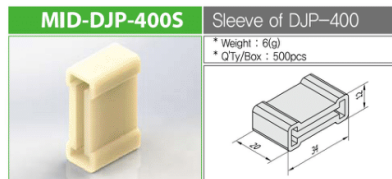
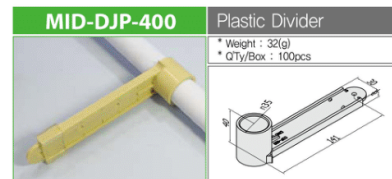
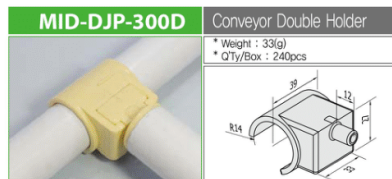
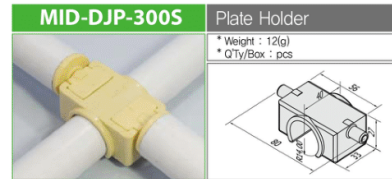
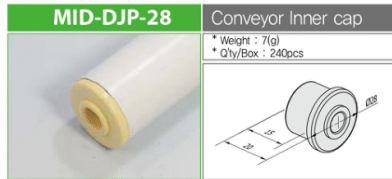

PWC Specification												
Series	Type	Part No	Load Capacity	Roller Diameter (mm)	Roller Pitch (mm)	Frame Material	ESD	Roller Color				Standard Length(M)
								WHITE	BLACK	IVORY	GREY	
40	Standard	PWC-4035S	150	32	35	SPCC		●				4
	ESD Black	PWC-4035E	150	32	35	SPCC	●					
	Flange	PWC-4050F	150	32	50	SPCC		●				
	ESD Flange	PWC-4050EF	150	32	50	SPCC	●		●			
	Rubber	PWC-4035R	150	32	35	SPCC				●	●	
60	Standard	PWC-6018S	120	16	18	SPCC		●				
	Rubber	PWC-6018R	120	16	18	SPCC	●		●			
	ESD Black	PWC-6018E	120	16	18	SPCC	●		●			
	Standard	PWC-6037S	170	30	37	SPCC		●				
	ESD Black	PWC-6037E	170	30	37	SPCC	●					
	Rubber	PWC-6037R	170	30	37	SPCC				●	●	
	AL Standard	PWC-6033S	200	30	33	Aluminium		●				
	AL Rubber	PWC-6033E	200	30	33	Aluminium				●	●	
	AL ESD Rubber	PWC-6033R	200	30	33	Aluminium	●			●		
	80	Standard	PWC-8037S	360	35	37	SPCC		●			
Multi Roller		PWC-8023SM	360	33	23	SPCC		●				
Standard		PWC-8050S	350	40	50	SPCC		●				
ESD Black		PWC-8050E	350	40	50	SPCC	●		●			
Rubber		PWC-8050R	350	40	50	SPCC				●	●	

### Part code system

MID-PWC	40	35	S	X
	Series No	Pitch(mm)	Roller Type	Color
	*30 SERIES	*Pitch 35mm	*S - STANDARD	*WH - WHITER
	*40 SERIES		*M - MULTI	*BK - BLACK
	*60 SERIES		*E - ESD	*IV - IVORY
	*80 SERIES		*F - FLANGE	*GR - GREY
			*EF - ESD FLANGE	*OR - ORANGE
			*R - RUBBER	*BL - BLUE
			*ER - ESD RUBBER	



## PLASTIC WHEEL CONVEYOR

### PWC 40 - Series

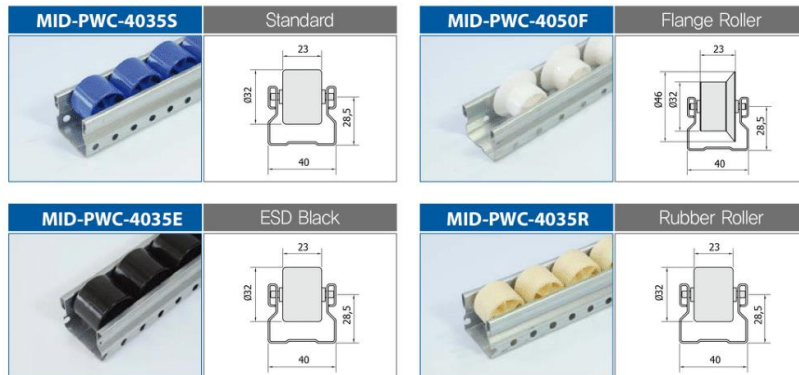

### PWC 60 - Series

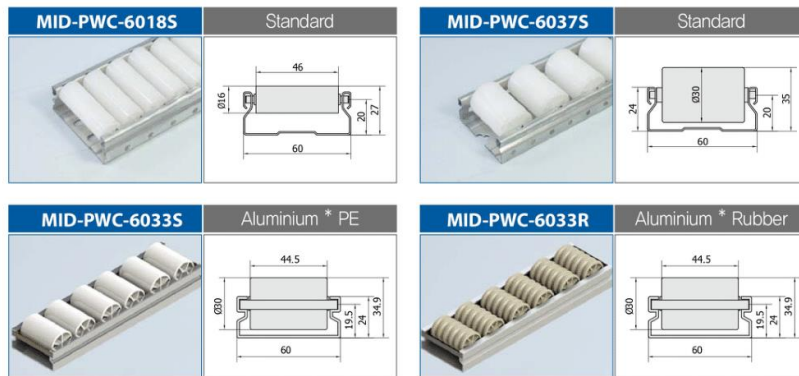

### PWC 80 - Series

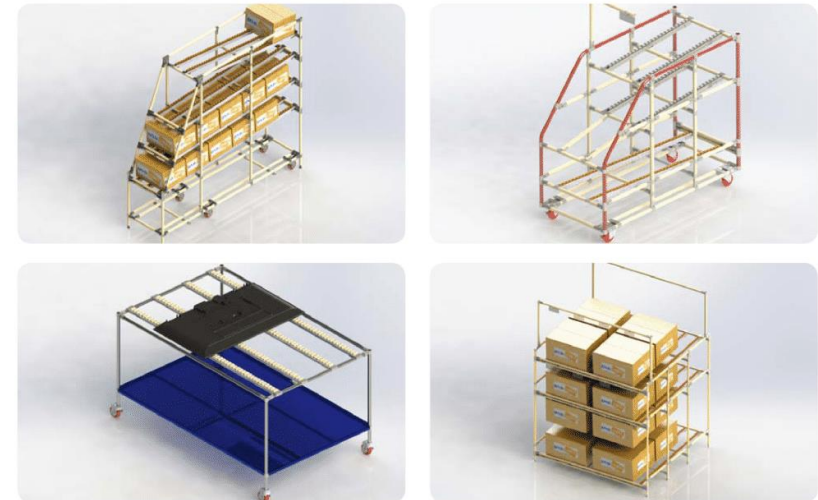
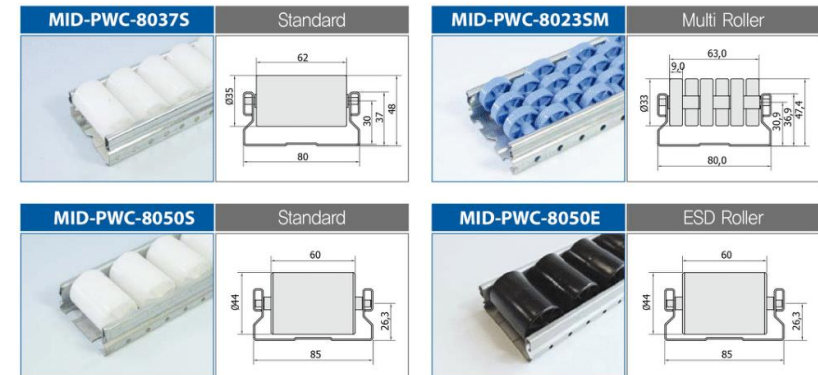



## PWC MOUNT BRACKETS

### Part code system

MID-PWC

60

Type

- \*30 SERIES
- \*40 SERIES
- \*60 SERIES
- \*80 SERIES

SA

Part No

- \*SA
- \*SB
- \*SB3
- \*SB233

X

Color

- \*Z - Zinc
- \*B - Black
- \*N - Nickel
- \*C - Chromium

## PWC MOUNT BRACKETS

### PWC 40 - Series

<b>MID-PWC-40A</b>	Mount Bracket * Weight : 118(g) * QTY/Box : 70pcs	<b>MID-PWC-40A1</b>	Mount Bracket * Weight : (g) * QTY/Box : 70pcs
<b>MID-PWC-40A33</b>	33-Mount Bracket * Weight : 143(g) * QTY/Box : 70pcs	<b>MID-PWC-40B</b>	Mount Bracket/Tap Stop * Weight : 151(g) * QTY/Box : 45pcs
<b>MID-PWC-40B2</b>	Mount Bracket/Tap Stop * Weight : 188(g) * QTY/Box : 60pcs	<b>MID-PWC-40B233</b>	33-Mount Bracket * Weight : 161(g) * QTY/Box : 70pcs
<b>MID-PWC-40C</b>	Center Support * Weight : 160(g) * QTY/Box : 70pcs	<b>MID-PWC-40C1</b>	Center Support * Weight : 154(g) * QTY/Box : 30pcs
<b>MID-PWC-40C2</b>	Center Support * Weight : 65(g) * QTY/Box : 100pcs	<b>MID-PWC-40D</b>	Center Support * Weight : 219(g) * QTY/Box : 25pcs

## PWC MOUNT BRACKETS

### PWC 40 - Series

\* Usage :  $\phi 28$   
\* Unit : mm  
\* Color : Zinc/Black/Nickel/Chromium

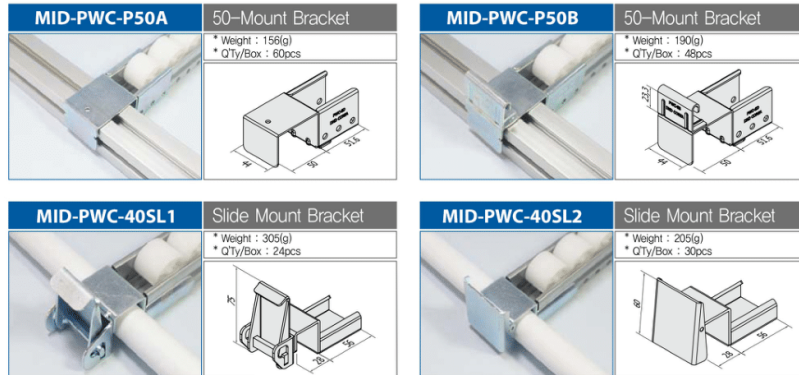

### PWC 60 - Series

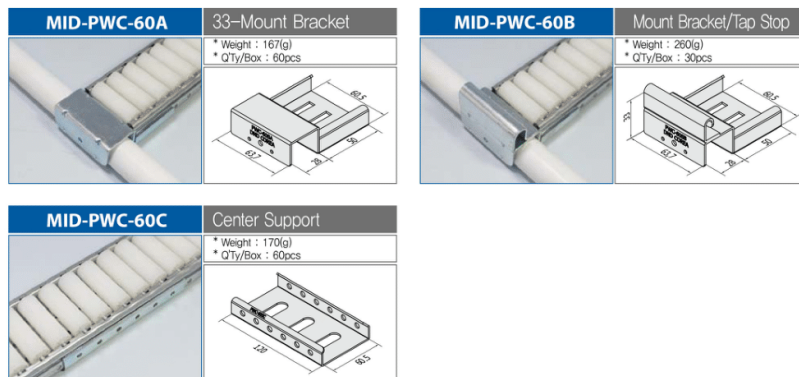

## PWC MOUNT BRACKETS

### PWC 80 - Series

\* Usage :  $\phi 28$   
\* Unit : mm  
\* Color : Zinc/Black/Nickel/Chromium

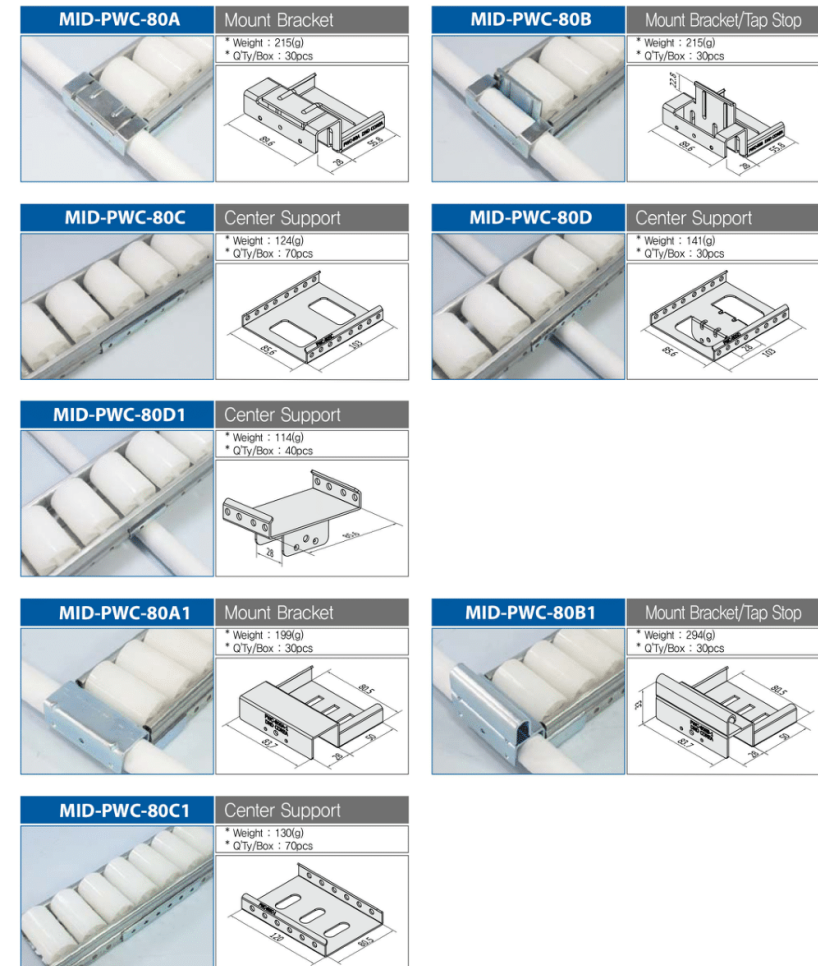

## SLIDE PIPE MOUNT

\*Usage :  $\Phi 28$   
 \*Unit : mm  
 \*Color : Zinc/Black/Nickel/Chromium



## SLIDE PIPE MOUNT BRACKETS

### Part code system

MID-PB	SA	X
Type	Part No	Color
*PB - Pipe Bracket	*SA	*Z - Zinc
	*SB	*B - Black
	*SB3	*N - Nickel
	*SB333	*C - Chromium

<b>MID-PB-SA</b>	Slide Pipe Mount * Weight : 105(g) * QTY/Box : 100pcs	<b>MID-PB-SA33</b>	33-Slide Pipe Mount * Weight : 114(g) * QTY/Box : 100pcs
<b>MID-PB-SB</b>	Slide Pipe Mount * Weight : 128(g) * QTY/Box : 90pcs	<b>MID-PB-SB3</b>	Slide Pipe Mount * Weight : 135(g) * QTY/Box : 90pcs
<b>MID-PB-SB333</b>	33-Slide Pipe Mount * Weight : 123(g) * QTY/Box : 90pcs	<b>MID-PB-SC</b>	Center Support * Weight : 67(g) * QTY/Box : 100pcs
<b>MID-PB-SD1</b>	ALL Pipe Mount * Weight : 107(g) * QTY/Box : 100pcs	<b>MID-PB-C2P</b>	50-AL Mount * Weight : 77(g) * QTY/Box : 100pcs
<b>MID-PB-I</b>	Profile Mount * Weight : 58(g) * QTY/Box : 200pcs	<b>MID-PB-H</b>	Profile Mount * Weight : 107(g) * QTY/Box : 100pcs



## ACCESSORIES

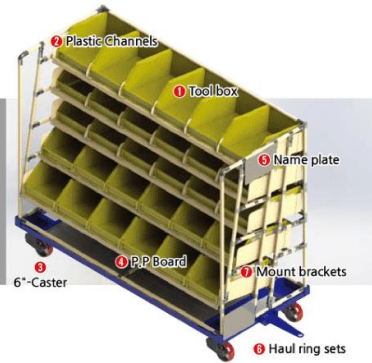

### Part code system

Part No	Color	Plating
*CB09H	*IV - IVORY	*Z - Zinc
*A30	*BK - BLACK	*B - Black
*HC-28A	*BL - BLUE	*N - Nickel
	*GE - GREEN	*C - Chromium
	*RD - RED	

### CONTENTS

- ▶ Mount Brackets
- ▶ Haul Ring Sets
- ▶ Bushing & Leveling Foot
- ▶ Plastic Channels
- ▶ Name Plates
- ▶ Wire Rack
- ▶ Accessories of Aluminium Pipe
- ▶ Board & Sheets
- ▶ Fasteners
- ▶ Casters

## Mount Brackets

• Usage :  $\phi 28$   
• Unit : mm  
• Color : Zinc/Black/Nickel/Chromium

<b>MID-PB-SE</b>	Caster Mount * Weight : 102(g) * QTY/Box : 150pcs	<b>MID-PB-E1</b>	Caster Mount * Weight : 136(g) * QTY/Box : 120pcs
<b>MID-PB-L</b>	Pipe Lock Bracket * Weight : 151(g) * QTY/Box : 50pcs	<b>MID-PB-UA</b>	Base Lock Bracket * Weight : 63(g) * QTY/Box : 150pcs
<b>MID-TH-5001B</b>	Tool Holder * Weight : 37(g) * QTY/Box : 100pcs	<b>MID-PB-UB</b>	Pipe Clamp(Double) * Weight : 27(g) * QTY/Box : 200pcs
<b>MID-PB-UC</b>	Pipe Clamp(Single) * Weight : 17(g) * QTY/Box : 300pcs	<b>MID-PB-TE</b>	Band Hanger Metal * Weight : 30(g) * QTY/Box : 100pcs
<b>MID-D-CSS</b>	Conner Metal Single * Weight : 97(g) * QTY/Box : 100pcs	<b>MID-D-CSP</b>	Conner Metal Double * Weight : 69(g) * QTY/Box : 100pcs

## Mount Brackets

• Usage :  $\phi 28$   
• Unit : mm  
• Color : Zinc/Black/Nickel/Chromium

<b>MID-PB-CA</b>	<b>Pipe Connector</b> • Weight : 72(g) • QTY/Box : 100pcs	
<b>MID-HR</b>	<b>Hanger Ring</b> • Weight : 10(g) • QTY/Box : 500pcs	
<b>MID-BS-A</b>	<b>Work Stopper A</b> • Weight : 28(g) • QTY/Box : 240pcs	
<b>MID-BS-A1</b>	<b>Work Stopper A1</b> • Weight : 15(g) • QTY/Box : 240pcs	
<b>MID-DJP-114</b>	<b>2020 Inner Cap</b> • Weight : 3(g) • QTY/Box : 500pcs	
<b>MID-DJP-115</b>	<b>2525 Inner Cap</b> • Weight : 3(g) • QTY/Box : 500pcs	
<b>MID-FH-A</b>	<b>Flat Handle-A</b> • Weight : 20(g) • QTY/Box : 500pcs	
<b>MID-RH-R</b>	<b>Round Handle-R</b> • Weight : 20(g) • QTY/Box : 500pcs	
<b>MID-BH</b>	<b>Band Holder</b> • Weight : 13(g) • QTY/Box : 500pcs	
<b>MID-SL3</b>	<b>Slide Stopper</b> • Weight : 260(g) • QTY/Box : 20pcs	

<b>MID-HC-28A</b>	<b>Hole Cup</b> • Weight : 344(g) • QTY/Box : 20pcs	
<b>MID-HC-28B</b>	<b>Hole Cup</b> • Weight : 382(g) • QTY/Box : 20pcs	



PIPE  
METAL JOINTS  
PLASTIC JOINTS  
PLASTIC WHEEL CONVEYOR  
PVC MOUNT BRACKETS  
SLIDE PIPE MOUNT BRACKETS  
ACCESSORIES  
TECHNICAL SPECIFICATIONS  
APPLICATIONS

## Haul Ring Sets

\*Color : Zinc/Black/Nickel/Chromium

Composition	Item	Part No	Material	Dimension(mm)	Weight(kg)	Color	Usage
Manual Lock	Front	MID-FHR-H	SPHC		2.8	ZINC	현대
	Rear	MID-RHR-H1	SPHC		1.1	ZINC	
	Rear	MID-RHR-H2	SPHC		1.1	ZINC	
	Rear	MID-RHR-H3	SPHC			ZINC	
Auto Lock	Front	MID-FHR-K	SPHC			ZINC	기아
	Rear	MID-RHR-K1	SPHC			ZINC	
Auto Lock	Front	MID-FHR-L	SPHC			ZINC	엘지
	Rear	MID-RHR-L1	SPHC			ZINC	
Auto Lock	Front	MID-FHR-A	SPHC		2.1	ZINC	Pipe Assembly
	Rear	MID-RHR-B	SPHC		1.0	ZINC	
	Rear	MID-RHR-C	SPHC		1.3	ZINC	



## Bushing & Leveling Foot

\*Usage : Φ28

\*Unit : mm

\*Color : Zinc/Black/Nickel/Chromium

### Threaded Metal Inserts

Type	Part No	Item	Dimension(mm)	Diameter(A)	Threaded Spec	Q'ty/Box	Material	Color
Coated Pipe	MID-CB07H			Φ24.1	1/2" - 12N	300	Steel	ZINC
	MID-CB07H2			Φ23.5	1/2" - 12N	300	Steel	ZINC
	MID-CB10H			Φ21.9	1/2" - 12N	300	Steel	ZINC
	MID-CB10H2				1/2" - 12N	300	Steel	ZINC
	MID-CB20H				1/2" - 12N	300	Steel	ZINC
MID-CB20H2								
STS Pipe	MID-CBP10H			Φ23.5	1/2" - 12N	300	Plastic	IVORY
	MID-SB07H			Φ26.8	1/2" - 12N	300	Steel	ZINC
	MID-SB07H2				1/2" - 12N	300	Steel	ZINC
	MID-SB09H				1/2" - 13N	301	Steel	ZINC
	MID-SB09H2			Φ26.1	1/2" - 13N	301	Steel	ZINC
	MID-SB11H				1/2" - 14N	302	Steel	ZINC
	MID-SB11H2							
MID-SB07H						Plastic	IVORY	

### Leveling Foot

Type	Part No	Item	Dimension(mm)	Threaded Spec	Q'ty/Box	Material	Color
Coated, STS Pipe	MID-A30			1/2" - 12N	250	Steel	ZINC
	MID-A30100H			1/2" - 12N	50	Steel	ZINC
	MID-A50HR			1/2" - 12N	100	Steel/Rubber	ZINC/GREY
	MID-A50H			1/2" - 12N	100	Steel	ZINC
	MID-A50HE			1/2" - 12N (ESD)	100	Steel/Rubber	ZINC/BLACK
	MID-A50100H			1/2" - 12N	50	Steel	ZINC





## Plastic Channels

\*Color : Ivory/Grey

Type	Part No	Configuration	Dimension (mm)		Thickness (mm)	Length (M)	Material	Color
			A	B				
A	MID-PC1		30	50	3.7	3	PVC	IVORY
	MID-PC2		28	30	3.5	3	PVC	IVORY
	MID-PC3		30	120	4	3	PVC	IVORY
	MID-PC4		50	50	4	3	PVC	IVORY
	MID-PC5		50	70	4	3	PVC	IVORY
	MID-PC6		50	100	4	3	PVC	IVORY
	MID-PC7		50	150	4	3	PVC	IVORY
	MID-PC8		100	60	5	3	PVC	IVORY
B	MID-PC9		100	50	3	3	PVC	IVORY
	MID-PC9A		36	33	3	3	PVC	IVORY
C	MID-PC10		28	-	2.5	3	PVC	IVORY
D	MID-PC11		40	59	3	3	PVC	IVORY
E	MID-PC12		47	70	3	3	PVC	IVORY
F	MID-PC13		66	75	3	3	PVC	IVORY
G	MID-PC14		66	75	3	3	PVC	IVORY

## Wire Rack

Part No	Configuration	Pipe	Dimension (mm) A	Weight (Kg)	Color
MID-WR-A		Φ28	240	0.193	ZINC
MID-WR-B			340	0.238	ZINC
MID-WR-C			440	0.282	ZINC

## Sealing Strip of Al Pipe

Part No	Configuration	Pipe Type	Length(M)	Material	Color
MID-AL-SP01		AL2820	1M	Silicone	White
MID-AL-SP02			1M	Silicone	Grey
MID-AL-SP03			1M	Silicone	Red
MID-AL-SP04			1M	PE	White

## Roller Mat Conveyor

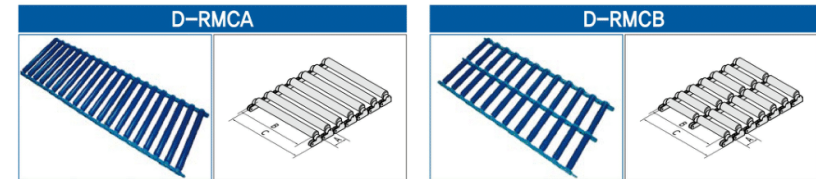

R.M.C Specification							
Part No	Dimension(mm)			Height(H)	Load Capacity (Kg/M)	APROX. Weight (Kg/M)	Material
	A	B	C				
MID-D-RMCA	80	455	497	75	200	5.4	ABS
MID-D-RMCB	105	455	497	75	400	6.8	ABS

## Pipe roller conveyor

Part No	Configuration	Dimension(mm)					Usage
		A	B	C	D	E	
MID-PRC-S28		1500	450	518	100	100	Coated&STS pipe
MID-PRC-D28		1500	450	518	100	100	

## Name Plate

Part No	Configuration	Dimension(mm)		Material	Usage
		A	B		
MID-NP1		150	60	PVC	Coated&STS pipe
MID-NP2		180	60	PVC	
MID-NP3		300	120	PVC	
MID-NP4		300	210	PVC	
MID-NP5		420	300	PVC	Plastic Board & Sheet
MID-NPV1		80	60	VINYL	
MID-NPV2		100	80	VINYL	
MID-NPV3		110	110	VINYL	
MID-NPV4		120	120	VINYL	
MID-NPV5		140	120	VINYL	
MID-NPV6		150	150	VINYL	
MID-NPV7	297	210	VINYL		

### Board & Sheets

Type	Material	Classification	Dimension (mm)	Thickness(mm)	Color
Plastic Board	PP/PE		1,000mm*2,000mm 1,200mm*2,400mm	T3, T5, T8, T10, T15	GREY/WHITE
	BAKELITE		1,000mm*1,000mm 1,000mm*1,200mm 1,000mm*2,000mm	T4, T5, T6, T8, T10, T12, T15	BASIC/IVORY
	PE SHEET		1,500mm*5,000mm	T4, T8, T10	GENERAL
	PVC		1,000mm*2,000mm 1,200mm*2,400mm	T3, T4, T6, T8, T10, T12	GREY/BLACK/ IVORY
Wood	PB BOARD		1,200mm*2,400mm	T15	BRAWON
	MDF		1,000mm*2,000mm 1,200mm*2,400mm	T6, T9, T12, T15	BASIC
	PLY WOOD		1,000mm*2,000mm 1,200mm*2,400mm	T8, T12	BASIC
Rubber MAT	ESD MAT		900mm/1,200mm	T3	GREEN
	GENERAL MAT		900mm/1,200mm	T3	GREEN
Tube	SILICONE/PVC		2,000mm	Φ30*Φ38	RED/GENERAL
Sponge	EVA		1,000mm*2,000mm 1,200mm*2,400mm	T5 ~ T100	GENERAL

### Fasteners

Type	Part No	Item	Specification	Q'ty/Box	Usage	Color
Bolt	MID-BM625Z		M6 x 25mm	5000	Metal Joint	ZINC
	MID-BM625B		M6 x 25mm	5000		BLACK
	MID-BM627Z		M6 x 27mm	5000		ZINC
	MID-BM627B		M6 x 27mm	5000	BLACK	
	MID-BM810Z		M8 x 10mm	400	Base Lock	ZINC
	MID-BM835Z		M8 x 35mm		Caster	
MID-BM840Z		M8 x 40mm	Caster			
Knob Bolt	MID-BM112Z		1/2-12U x 50mm	400	Bushing	ZINC
	MID-4NB6M		M6 x 35mm	300	Bracket	BLACK
	MID-4NB8M		M8 x 35mm	300	Bracket	BLACK
	MID-SNB6M		M6 x 30mm	300	Bracket	BLACK
	MID-SNB8M		M8 x 30mm	300	Bracket	BLACK
	Nut	MID-TNM6Z		M6	1000	Metal Joint
MID-TNM6B			M6	1000	Metal Joint	BLACK
MID-NM6Z			M6	1000	Metal Joint	ZINC
MID-NM6B			M6	1000	Metal Joint	BLACK
MID-TNM8Z			M8	1000	Caster	ZINC
MID-NNM6			M6 (Nylon Nut)	1000	Metal Joint	ZINC
MID-NNM8			M8 (Nylon Nut)	1000	Caster	ZINC
MID-NM12Z			1/2-12U x 30mm	1000	Bushing	ZINC
Washer	MID-WH		M6	2000	Bracket	ZINC

## CASTERS



3	T	S	B	N	1
Wheel Size	Type	Type	Brake	Usage	Wheel Material
*2 - 2"	*T - Thread	*S - Swivel	*N - Normal	*N - Normal	*1 - Soft Rubber
*25 - 2.5"	*P - Top Plate	*R - Rigid	*B - Brake	*H - Heavy	*2 - Polyurethane
*3 - 3"	*F - Fastening Rubber		*DB - Double Brake	*HS - Heavy (Spring)	*3 - ESD
*4 - 4"					
*5 - 5"					
*6 - 6"					



Midra Việt Nam là đại lý chính thức bánh xe đẩy mang thương hiệu UKai- Nhật Bản. Là thương hiệu bánh xe công nghiệp lâu đời và rất có uy tín trên thị trường.

Midra Vietnam is the authorized distributor of UKai brand caster wheels from Japan. UKai is a well-established and highly reputable industrial wheel brand in the market.



**Bánh xe cố định**

Φ75 - Φ100 - Φ130 - Φ150 - Φ200 - Φ250  
Model: **MID-BX1**



**Bánh xe xoay**

Φ75 - Φ100 - Φ130 - Φ150 - Φ200 - Φ250  
Model: **MID-BX2**



**Bánh xe xoay, có khóa**

Φ75 - Φ100 - Φ130 - Φ150 - Φ200 - Φ250  
Model: **MID-BX3**



**Bánh xe chịu tải cao**

Model: **MID-BX4**



**Bánh xe chịu nhiệt**

Model: **MID-BX5**



**Bánh xe chống tĩnh điện**

Model: **MID-BX6**

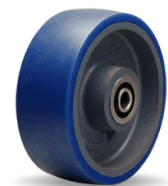

**Bánh xe chống hóa chất**

Model: **MID-BX7**



**Bánh xe chống bám bụi**

Model: **MID-BX8**



**Phụ kiện bánh xe**

## TECHNICAL SPECIFICATIONS



### Examples of application

1. Rubber Guide
2. Plastic Joint

### Technical specifications

1. Tightening Torque of Bolt & Nut in Pipe & Metal Joint
2. The Surface Resistance of ESD Pipe
3. How to Calculate the Horizontal Pipe Length
4. Bending Strength for Pipe
5. Bending Strength for PWC
6. Others

### Application

1. Slide Rack
2. Mobile Rack
3. Work Table
4. LCD for Mobile Rack
5. Others



## Rubber Guide

Part No	Configuration	Dimension(mm)	Material	Weight(g)	Color
MID-RSG-A			Polyurethane	30	IVORY YELLOW BLUE GREY BLACK
MID-RSG-B				67	
MID-RSG-C				30	
MID-RSG-D				32	
MID-RSG-E				80	
MID-RSG-FT				44	
MID-RSG-FS				37	
MID-RSG-FT1				40	
MID-RSG-FS1				34	
MID-RSG-G				85	
MID-RSG-FSA1				43	
MID-RSG-S01				42	
MID-RSG-S02				44	
MID-RSG-FSB				67	
MID-RSG-FSB1				70	
MID-RSG-FSC				49	
MID-RSG-FSC-1				50	
MID-RSG-FSC-2				46	
MID-RSG-FSC-3					

## Examples of applicaiton



Item name : Cover bottom  
Parts : Coated Pipe, AL2820,  
Rubber guide(FSC-2)  
Load Q'ty : 75EA

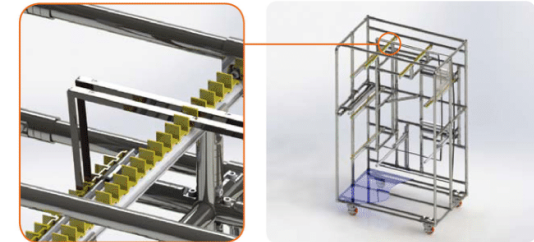

Item name : Case top chassis  
Parts : STS Pipe, AL2820,  
Rubber guide(FSB-2)  
Load Q'ty : 23EA

## Plastic Joint

### ■ DJP-400 / DJP-400S

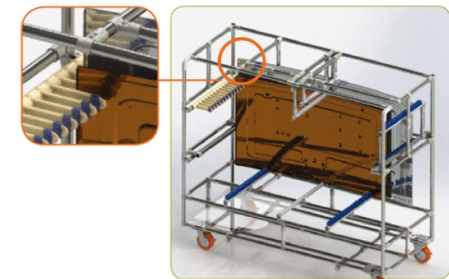
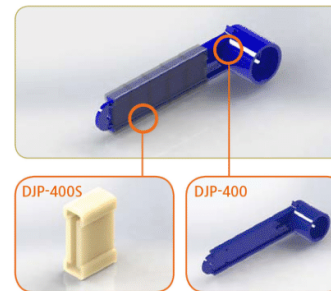

Item name : Cover bottom  
Parts : STS-Pipe, Rubber guide(G-type),  
DJP-400/400S  
Load Q'ty : 20EA

## TECHNICAL SPECIFICATIONS

- Coupling force between pipe and M6 bolting pressure:  
Min100Kgf.cm ~ Max150kgf.cm



- Conductive coating pipe resistance measurement value  
- General coated pipe surface resistance value:  $10^4 \sim 10^5$   
- Gray coated pipe surface resistance value:  $10^9 \sim 10^{10}$

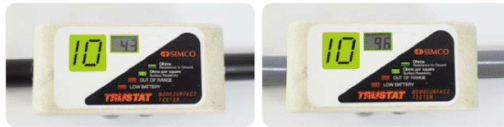

## Pipe Cutting

- METAL JOINT

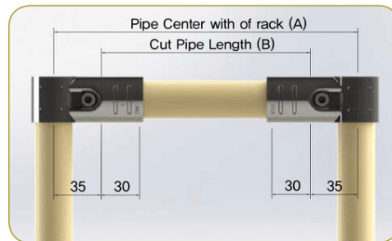

※  $B = A - (70) = B(\text{mm})$   
A = Pipe center to center  
B = Pipe cutting length  
70 = From horizontal pipe end to vertical  
Pipe center 35mmx2  
When the length of A is 1000mm. What is the length of B?  
⇒  $1000\text{mm} - 70\text{mm} = 930\text{mm}$

- PLASTIC JOINT

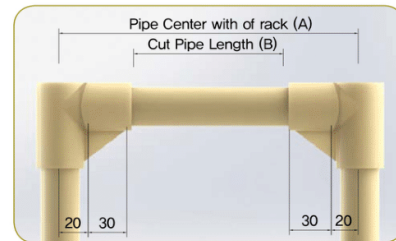

※  $B = A - (40) = B(\text{mm})$   
A = Pipe center to center  
B = Pipe cutting length  
40 = From horizontal Pipe end to vertical  
Pipe center 20mm x 2  
When the length of A is 1000mm. What is the length of B?  
⇒  $1000\text{mm} - 40\text{mm} = 960\text{mm}$

## BENDING STRENGTH FOR PIPE

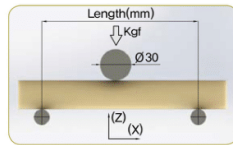

※ Test Condition  
Speed : 5mm/min

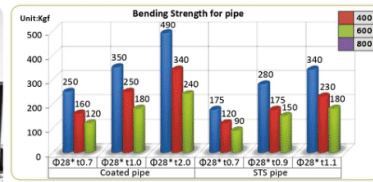

pipe Length(mm)	Spec of pipe					
	Coated pipe Φ28*10.7	Coated pipe Φ28*11.0	Coated pipe Φ28*12.0	STS pipe Φ28*10.7	STS pipe Φ28*10.9	STS pipe Φ28*11.1
400	250	350	490	175	280	340
600	160	250	340	120	175	230
800	120	180	240	90	150	180

## BENDING STRENGTH FOR PWC

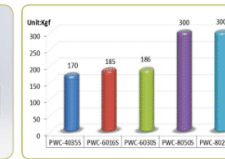
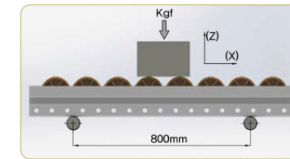

※ Test Condition (Speed : 5mm/min)

Classification	Spec of PWC				
	PWC-4035S	PWC-6016S	PWC-6030S	PWC-8050S	PWC-8023S
UNIT(Kgf)	170	185	186	300	300

## ANGLE OF SLOP FOR SLIDING

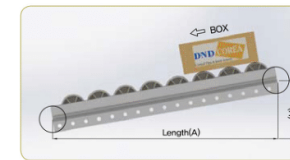

※ Test Condition  
(PWC Type : Standard / BOX SIZE : 300\*200\*150 / Weight : 1kg)

Classification	Length(A) 800mm				
	PWC-4035S	PWC-6016S	PWC-6030S	PWC-8050S	PWC-8023S
Angle(theta)	2.7	3	3	2.9	2.9

## COMPRESSION STRENGTH OF WHEEL

※ Test Condition (Speed : 5mm/min)

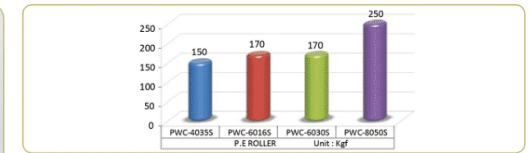
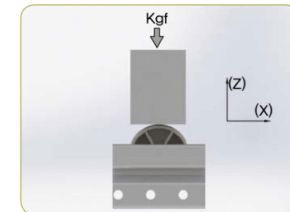

Classification	P.E ROLLER Unit : Kgf				
	PWC-4035S	PWC-6016S	PWC-6030S	PWC-8050S	PWC-8023S
UNIT	150	170	170	250	250

## THE HOLDING STRENGTH OF JOINT

※ Test Condition (Wrench Bolt Torque : 100Kgf-cm / Speed : 5mm/min)

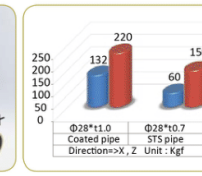
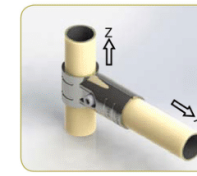

Classification	Direction=>X, Y Unit : Kgf	
	Coated pipe Φ28*11.0	STS pipe Φ28*10.7
X	132	40
Z	220	150

## STRENGTH OF WELD TEST

※ Test Condition (Voltage : 380V/22000A / Welding time : 4sec)

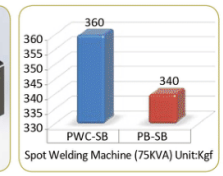

Classification	Spot Welding Machine (100KVA) Unit : Kgf	
	PWC-40B	PB-SB
	360	340



## Slide Rack



## Mobile Rack

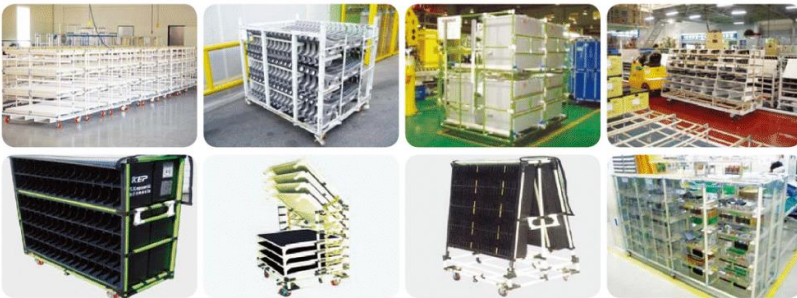

## Work Table



## LCD for Mobile Rack



## Others



PIPE  
METAL JOINTS  
PLASTIC JOINTS  
PLASTIC WHEEL CONVEYOR  
PVC MOUNT BRACKETS  
SLIDE PIPE MOUNT BRACKETS  
ACCESSORIES  
TECHNICAL SPECIFICATIONS

APPLICATIONS



# ALUMINUM PIPE D28 NHÔM ỐNG ĐỊNH HÌNH D28





## THÔNG TIN SẢN PHẨM / PRODUCT INFORMATION

Mã sản phẩm / Product code: **MID-23- D28**

Chiều dài / Length: **6.02m**

Cân nặng / Weight: **0.5kg/m**

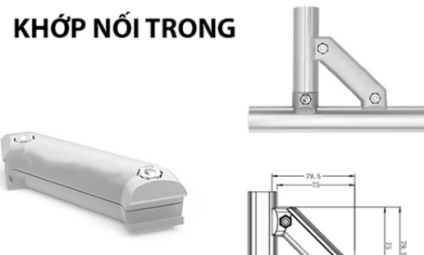
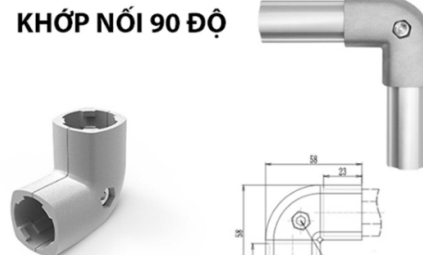
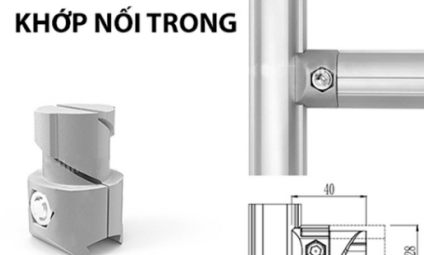
Mác nhôm / Aluminum grades: **6063 - T5**

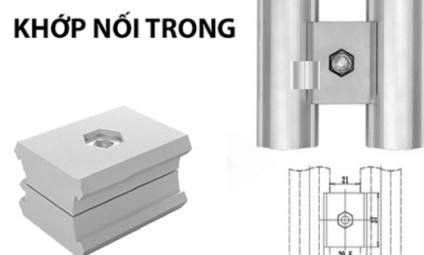
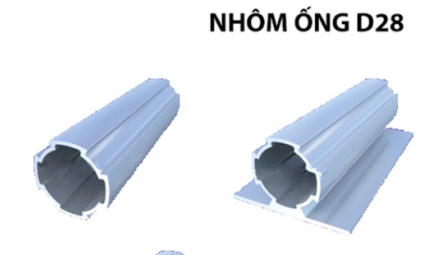
<p><b>KHỚP NỐI MD-QT2</b></p>  <p>Model: <b>MD-QT2</b> KLT: 37g D28mm Nhôm đúc, nhẵn đẹp</p>	<p><b>KHỚP NỐI NGOÀI</b></p>  <p>Model: <b>MD-QT1</b> KLT: 58g D28mm Nhôm đúc, nhẵn đẹp</p>	<p><b>KHỚP NỐI TRONG</b></p>  <p>Model: <b>MID-03</b> KLT: 102g D28mm Nhôm đúc, nhẵn đẹp</p>	<p><b>KHỚP NỐI 90 ĐỘ</b></p>  <p>Model: <b>MID-04</b> KLT: 94g D28mm Nhôm đúc, nhẵn đẹp</p>
<p><b>KHỚP NỐI TRONG</b></p>  <p>Model: <b>MID-01</b> KLT: 44g D28mm Nhôm đúc, nhẵn đẹp</p>	<p><b>KHỚP NỐI XOAY</b></p>  <p>Model: <b>MID-02</b> KLT: 119g D28mm Nhôm đúc, nhẵn đẹp</p>	<p><b>KHỚP NỐI TRONG</b></p>  <p>Model: <b>MID-05</b> KLT: 48g D28mm Nhôm đúc, nhẵn đẹp</p>	<p><b>NHÔM ỐNG D28</b></p> 



**Con Trượt Thuyền**  
MODEL: MID-PKN1



**Con Trượt Nhôm Định Hình**  
MODEL: MID-PKN2



**Con Trượt Trong Rãnh Nhôm**  
MODEL: MID-PKN3



**Con Trượt Vuông**  
MODEL: MID-PKN4



**Khóa Nam Châm**  
MODEL: MID-PKN13



**Tay Nắm Nhôm Định Hình**  
MODEL: MID-PKN14

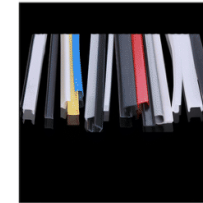

**Nẹp Rãnh Nhôm Định Hình**  
MODEL: MID-PKN15

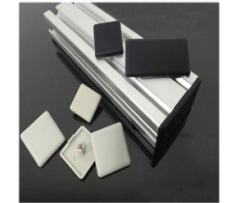

**Nắp Bịt Đầu Thanh Nhôm**  
MODEL: MID-PKN16



**Con Trượt Rãnh Nhôm**  
MODEL: MID-PKN5



**Bích Chân Tầng Chính**  
MODEL: MID-PKN6

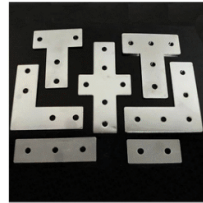

**Mặt Bích Nối Nhôm Định Hình**  
MODEL: MID-PKN7



**Bu lông Chữ T**  
MODEL: MID-PKN8



**Thanh Nối Nhôm Định Hình**  
MODEL: MID-PKN17



**Móc Treo Nhôm Định Hình**  
MODEL: MID-PKN18



**Khớp Xoay Nhôm Định Hình**  
MODEL: MID-PKN19

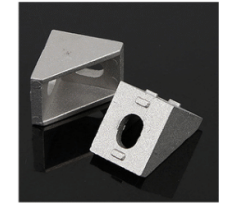

**Ke Góc Nhôm 20x20**  
MODEL: MID-PKN20



**Ke Chìm Nhôm Định Hình**  
MODEL: MID-PKN9

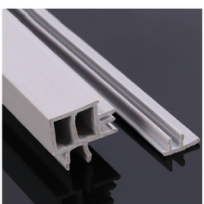

**Thanh Gá Vách Mica**  
MODEL: MID-PKN10

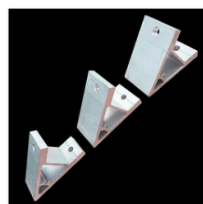

**Ke Góc 45 Độ**  
MODEL: MID-PKN11



**Bản Lề Nhôm Định Hình**  
MODEL: MID-PKN12



**Ke Góc Nhôm 30x30**  
MODEL: MID-PKN21



**Ke Góc Nhôm 45x45**  
MODEL: MID-PKN22

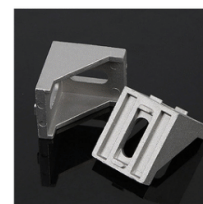

**Ke Góc Nhôm 40x40**  
MODEL: MID-PKN23



**Ke Góc Nhôm 60x60**  
MODEL: MID-PKN24



**Midra**  
Trustable always  
[www.midra.vn](http://www.midra.vn)

**CÔNG TY TNHH MIDRA VIỆT NAM**

VPGD: 78F TT9 Khu đô thị Văn Phú, Hà Đông, Hà Nội.

Tel: 024 6682 5694/ Fax: 0433 119 295

Hotline: 0982800084/ Midra@midra.vn